

MAIN STREET

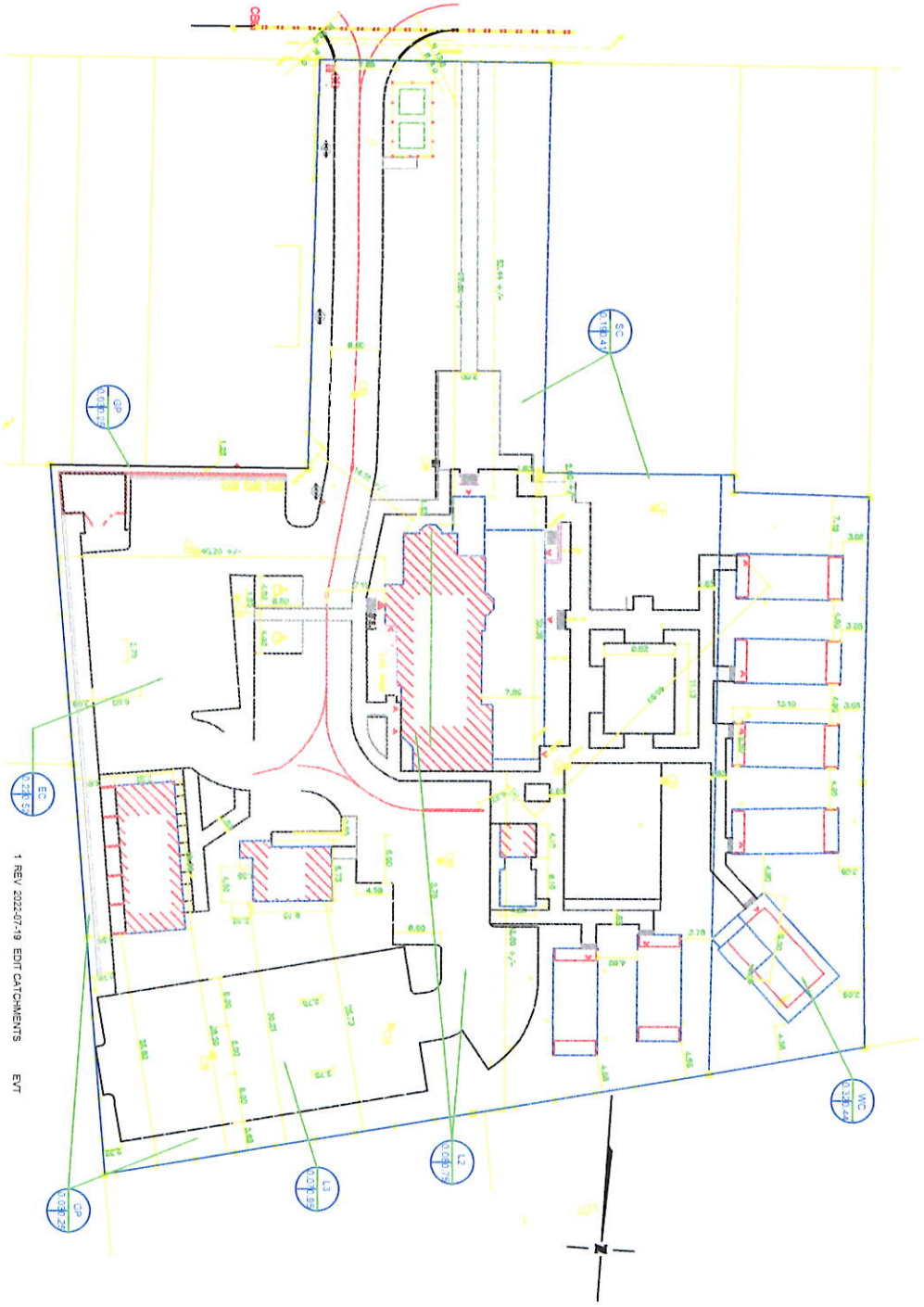

1 REV/ 2022/07/19 EDIT CATCHMENTS EWT

**WELLINGTON HOTEL
CATCHMENT AREAS**

- WEST CATCHMENT
- EAST CATCHMENT
- SOUTH CATCHMENT
- LOT#3
- LOT#2
- CATCHMENT D
- GREEN SPERMAL NORTH, EAST SOUTH
- ASSUMED FLAOR COEFFICIENT

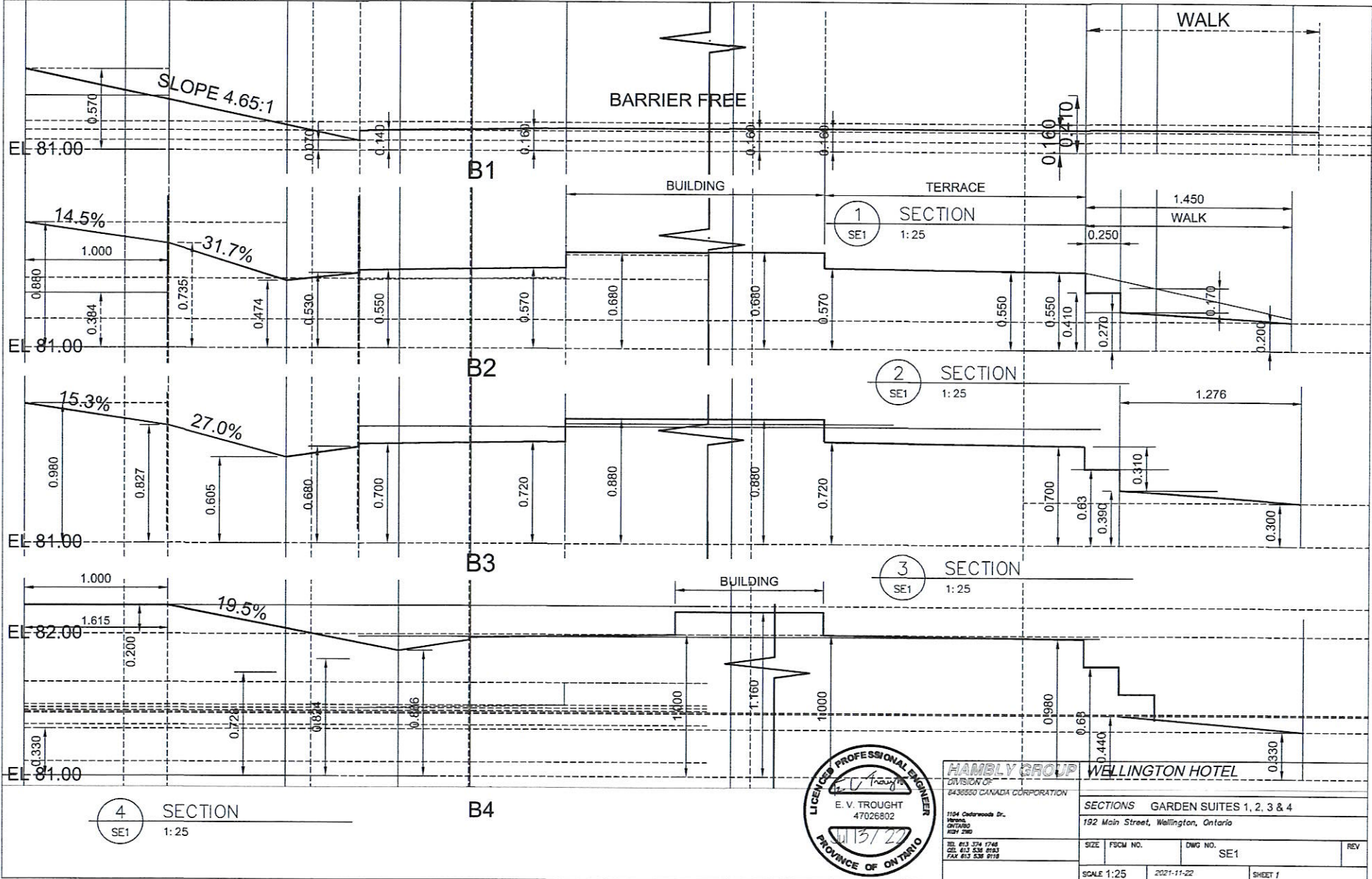

4 SECTION
SE1 1:25

B4



HAMBLY GROUP
DIVISION OF
6438550 CANADA CORPORATION
1104 Cedarwood Dr.,
Windsor,
ONTARIO
N9H 2N0
TEL: 813 374 1748
220-813-538 8153
FAX: 813-538-9178

WELLINGTON HOTEL			
SECTIONS GARDEN SUITES 1, 2, 3 & 4			
192 Main Street, Wellington, Ontario			
SIZE	FSCM NO.	DWG NO.	REV
SCALE 1:25		2021-11-22	SE1
		SHEET 1	

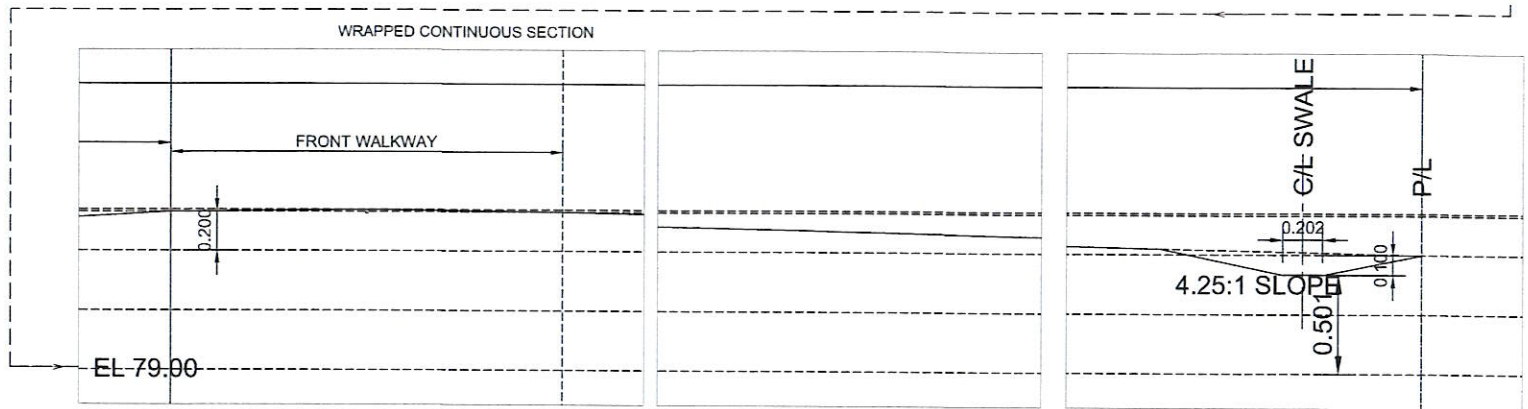
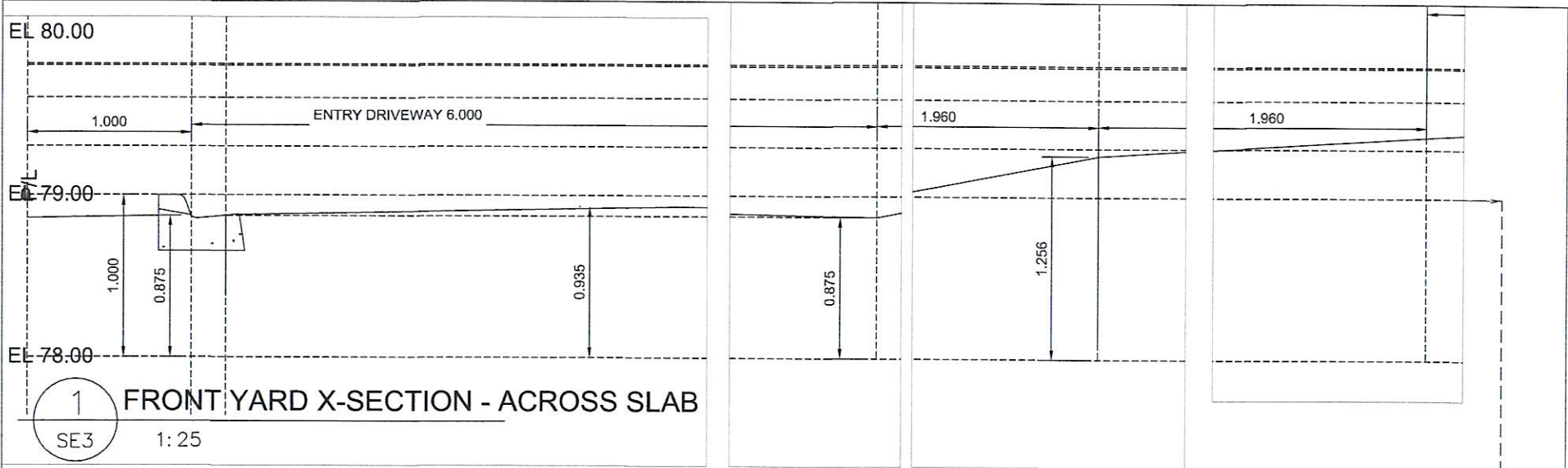

CURB DETAIL SHOWN ON D1.2



HAMELY GROUP		WELLINGTON HOTEL	
DIVISION OF 6436550 CANADA CORPORATION		SECTIONS X-SECTION 1/SE1	
1154 Cedarwoods Dr. Markham ON M3R 2W0		192 Main Street, Wellington, Ontario	
TEL: 613 374 1746	SIZE	FSCM NO.	DWG NO.
CO: 613 536 8131			SE3
FAX: 613 536 9118	SCALE 1:25	2021-11-22	SHEET 1

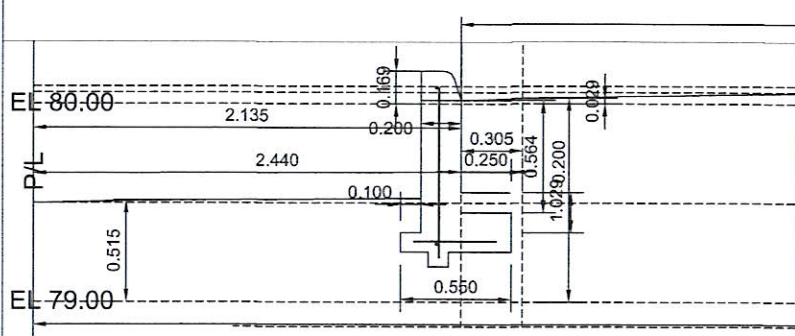

FRONT DRIVEWAY

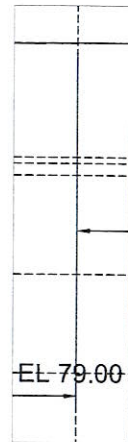
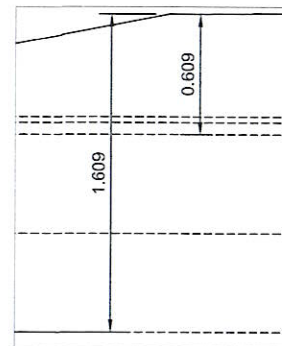
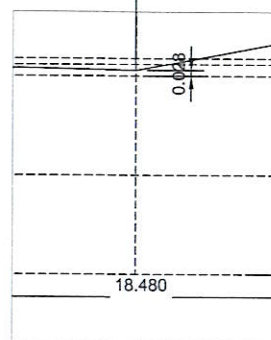
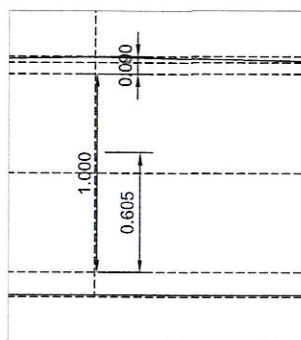

EL 79.00

1 FRONT YARD X-SECTION - NORTH
SE4 1:25

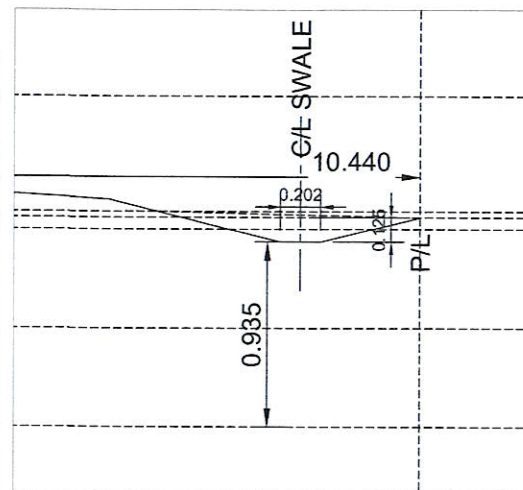
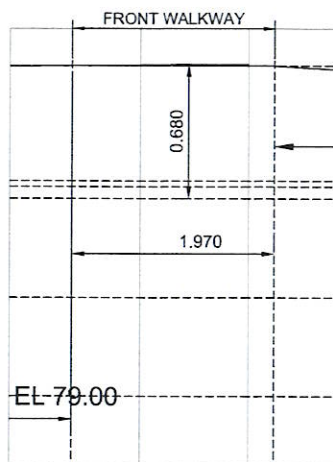

THE BERM ALONG THE WEST PROPERTY LINE MAY BE REPLACE WITH A LOW BERM [OF H=150-200 mm WITH SLOPES OF 4:1 ON BOTH SIDES TO EXITING ELEVATION THE PROPERTY LINE. RETAINING WALL DETAIL ON SP2.9

HAMBLY GROUP		WELLINGTON HOTEL	
DIVISION OF 8436550 CANADA CORPORATION			
1104 Cedarwood Dr. Windsor, ONTARIO N9H 1S9			
SECTIONS		X-SECTION 2/SE1	
192 Main Street, Wellington, Ontario			
SIZE	FSCM NO.	DWG NO.	REV
		SE4	
SCALE 1:25		2021-11-22	SHEET 1

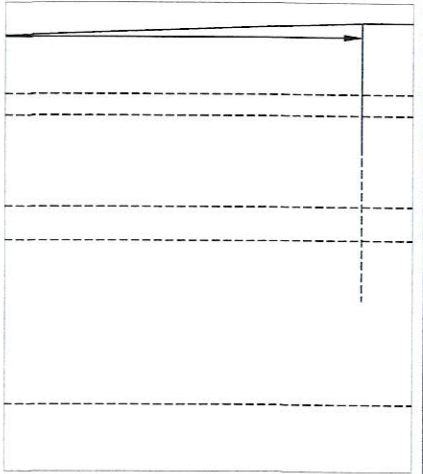
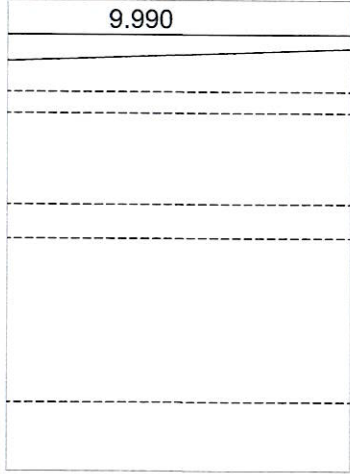
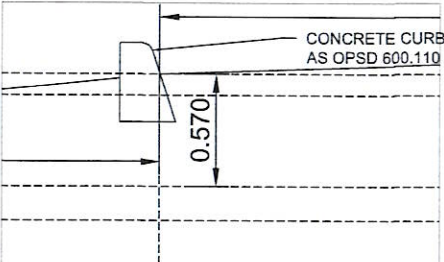
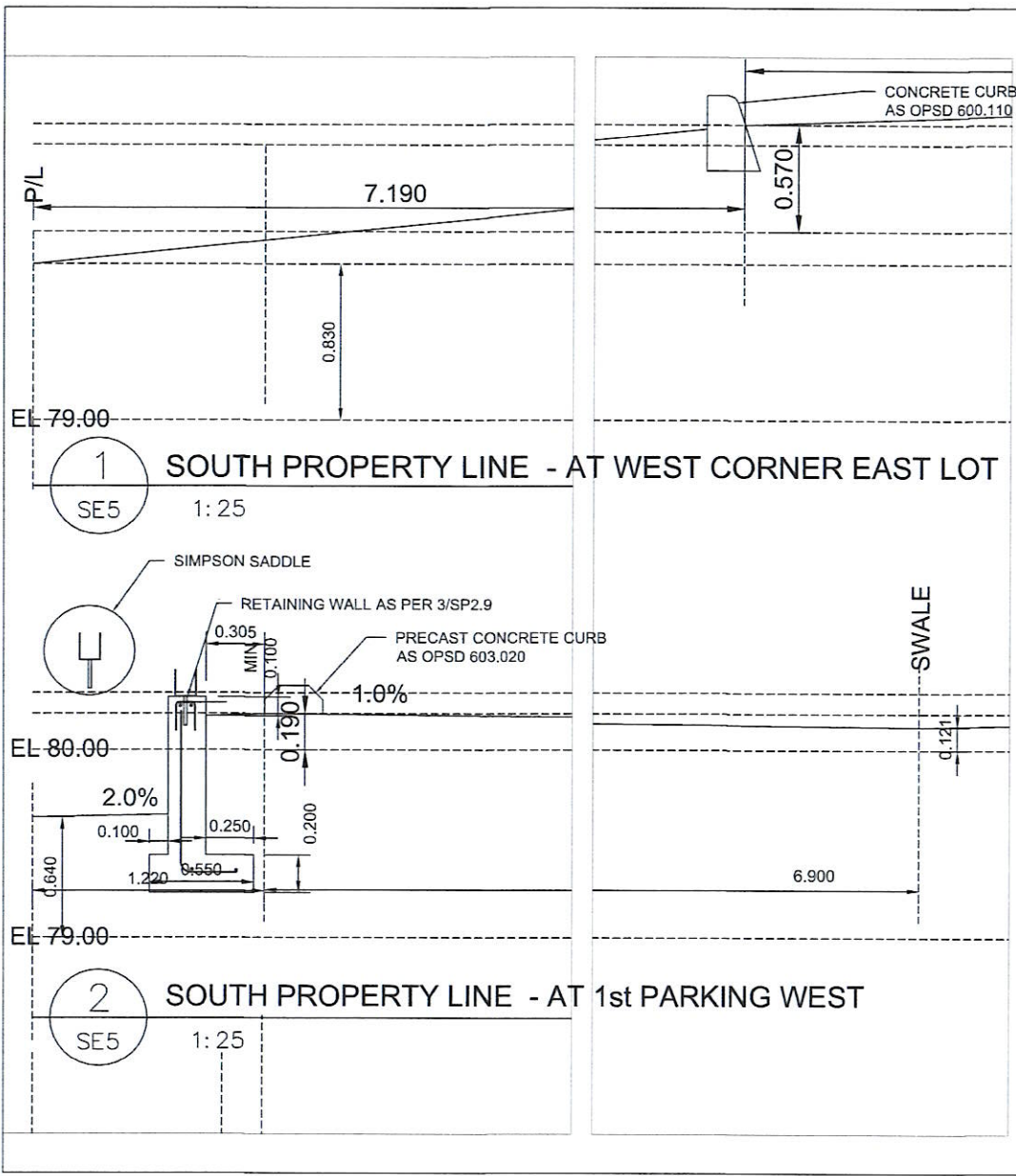

HAMBLY GROUP
DIVISION OF
8436550 CANADA CORPORATION
1154 Cedarwoods Dr.
Windsor,
ONTARIO
N9M 2S9
TEL: 613 374 1746
CELL: 613 536 6193
FAX: 613 536 9118

WELLINGTON HOTEL			
SECTIONS			
192 Main Street, Wellington, Ontario			
SIZE	FSCM NO.	DWG NO.	REV
		SE5	
SCALE 1:25	2021-11-22	SHEET 1	

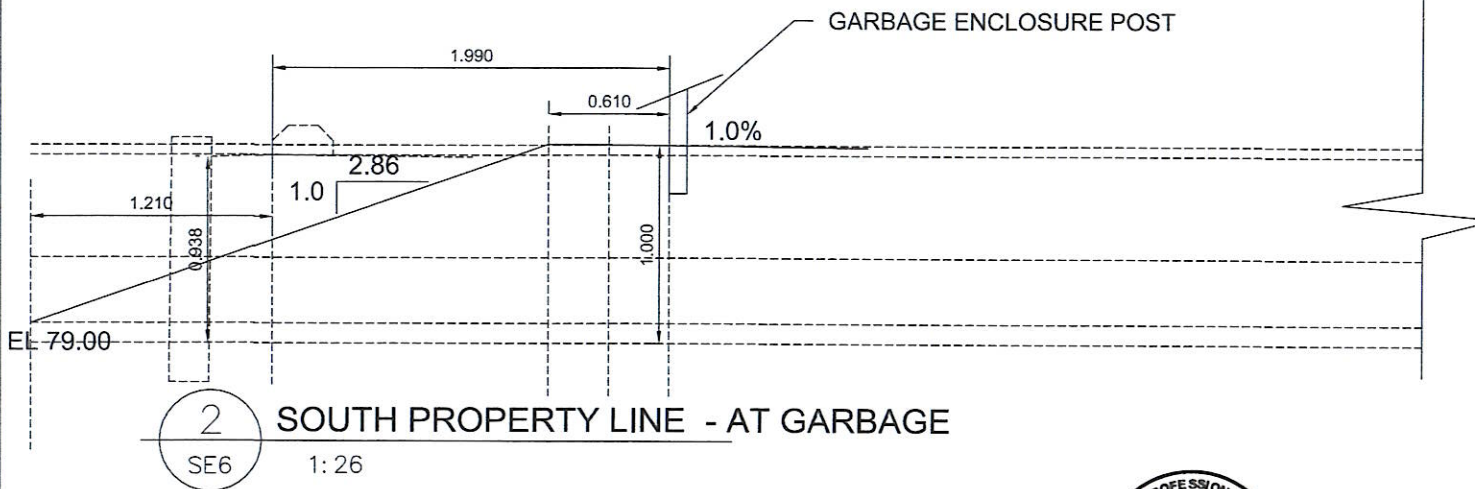
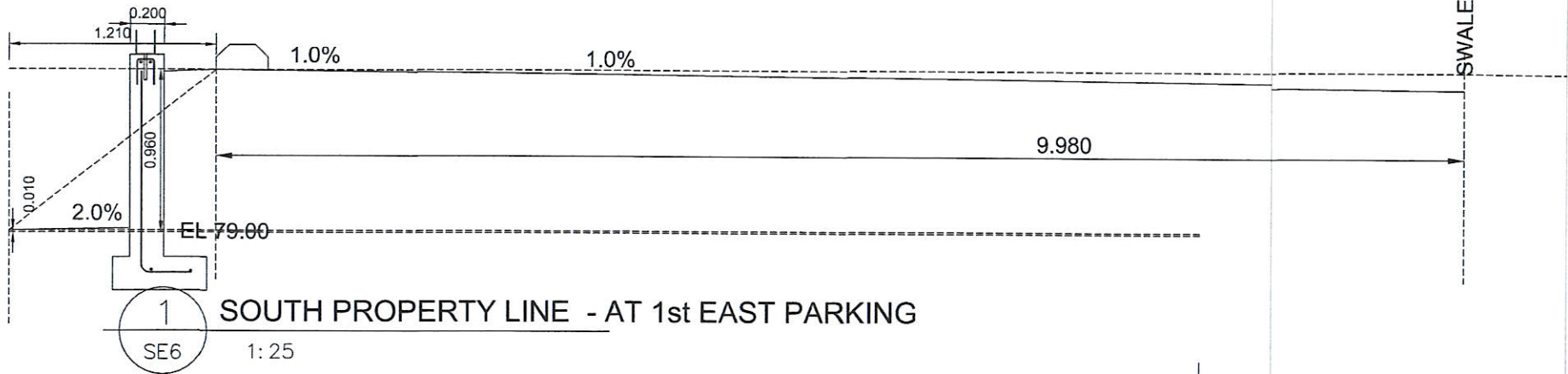

RETAINING WALL DETAIL ON SP2.9



HAMBLY GROUP
DIVISION OF
8438550 CANADA CORPORATION

7124 Cedarwood Dr.
Windsor,
ONTARIO
N9H 2J9

TEL: 613 374 1744
CEL: 613 336 6193
FAX: 613 336 9118

WELLINGTON HOTEL

SECTIONS

192 Main Street, Wellington, Ontario

SIZE	FSCM NO.	DWG NO.	REV
		SE6	

SCALE 1:25	2021-11-22	SHEET 1
------------	------------	---------

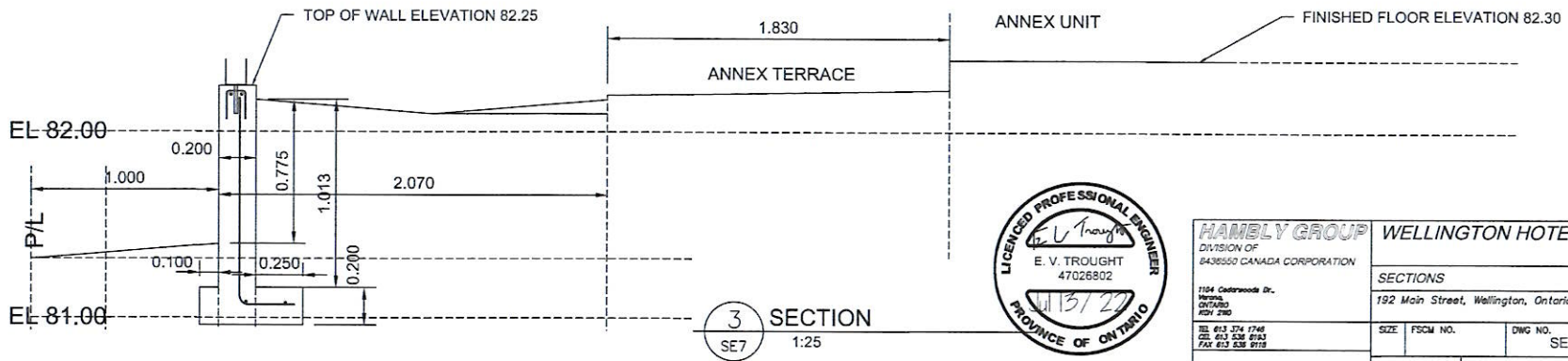
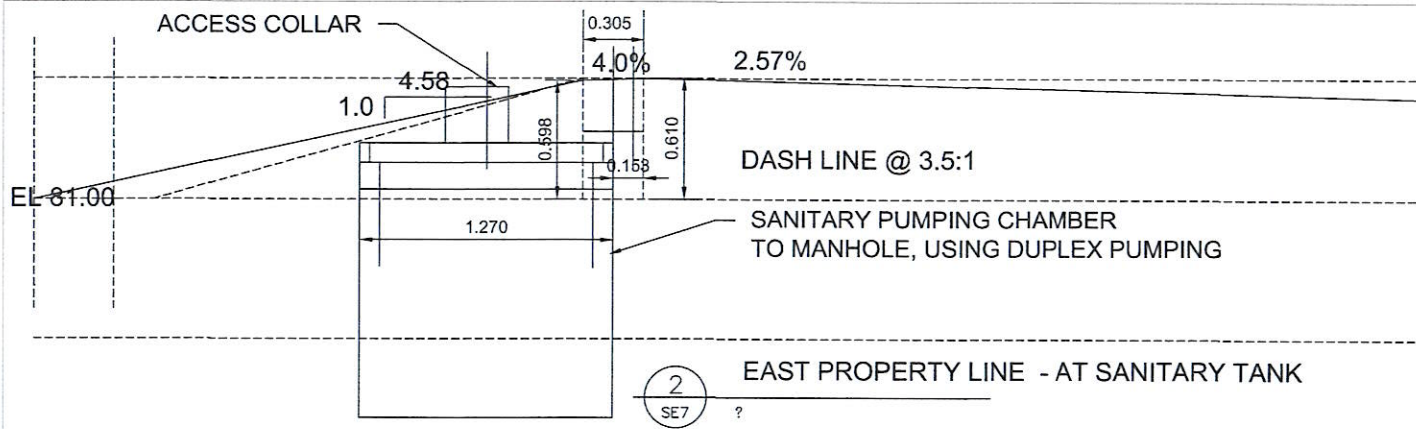
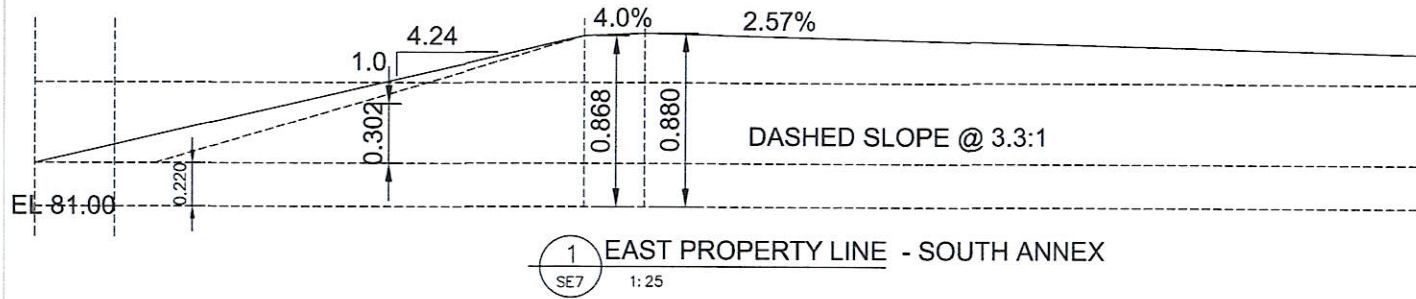

HAMELY GROUP
DIVISION OF
6436550 CANADA CORPORATION
1154 Cedarwoods Dr.,
Wexford,
ONTARIO
M9V 2R0
TEL: 613 374 1746
CELL: 613 536 8943
FAX: 613 536 9118

WELLINGTON HOTEL
SECTIONS
192 Main Street, Wellington, Ontario

SIZE	FSCM NO.	DWG NO.	REV
		SE7	

SCALE 1:25 2021-11-22 SHEET 1